

SERVICE CENTER; BETTER PACKAGING SYSTEMS
 P: 800-722-8002 F: 440-338-7046 E: KBOICE@ITAPE.COM

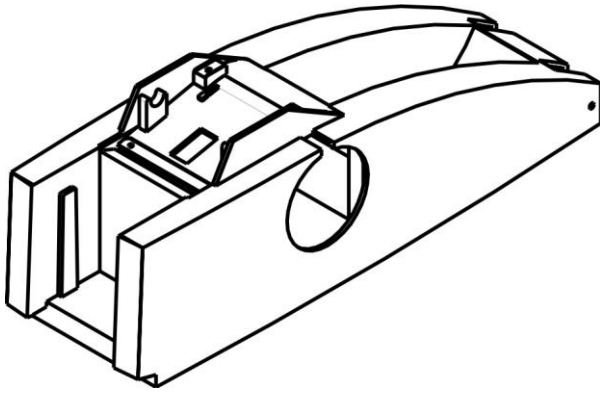

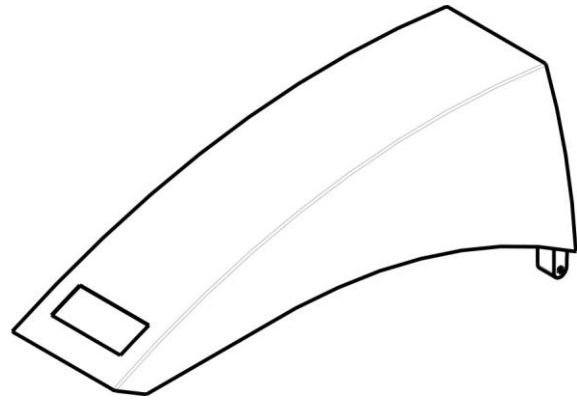

ITEM 1
012-865-0 - BASE



ITEM 2
012-867-0 - COVER



ITEM 3
012-883-0 - ROLL GUIDE



ITEM 4
012-879-0
PRESSURE PLATE

ITEM 5
023-777-0
SPACER, .144/.155ID x 5/16 LG



ITEM 6
012-884-0
TENSION SPRING

ITEM 7
012-877-1
ASSY, UPPER FEED WHEEL SHAFT

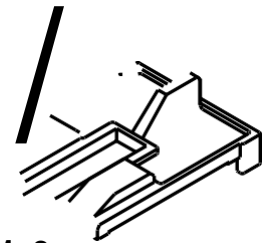

ITEM 8
012-871-0
TAPE WEIGHT

TAPESHUNTER 404
Ferrer Packages, Inc. ©
Shelton, CT 06484

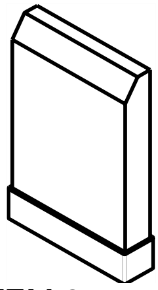

ITEM 9
012-898-0
BRUSH

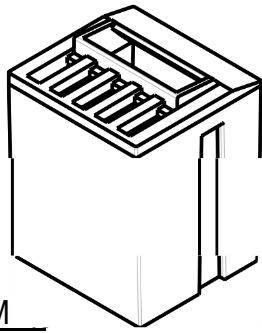

ITEM
012-869-1
ASSY. TANK



ITEM 11
012-885-0
CUTTER PLATE

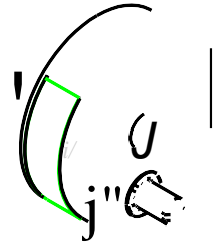

ITEM 12
012-858-1
ASSY. MEASURING DIAL

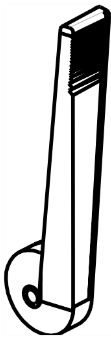

ITEM 13
012-958-0
OPERATING LEVER

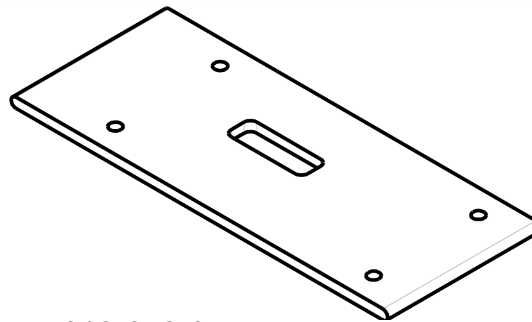

012-956-0
BASE PLATE

ITEM 15
012-881-0
FOOT

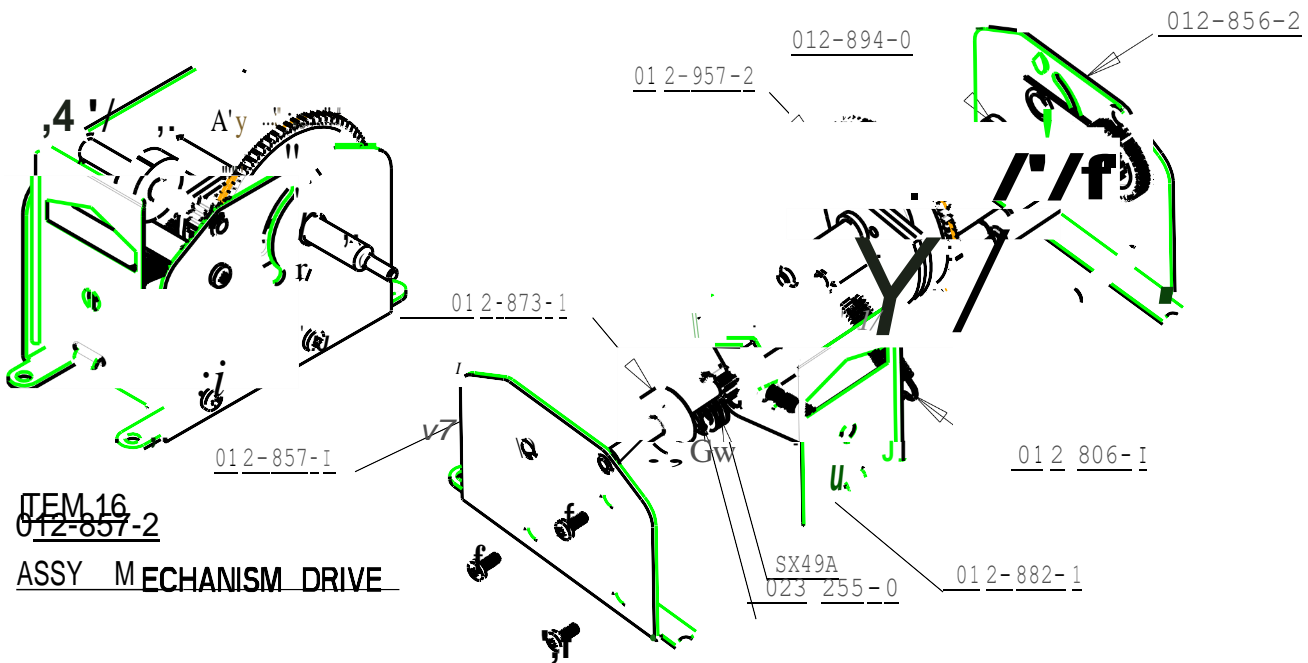

ITEM 16
012-857-2
ASSY MECHANISM DRIVE

TAPESHYPER ER 404



Ferrer Packages, Inc. ©

Shelton, CT 06484